

AC890

Modular AC Drives
1 - 500 HP



ENGINEERING YOUR SUCCESS.



Parker Electromechanical & Drives Division - Rohnert Park, CA

WARNING - USER RESPONSIBILITY

FAILURE OR IMPROPER SELECTION OR IMPROPER USE OF THE PRODUCTS DESCRIBED HEREIN OR RELATED ITEMS CAN CAUSE DEATH, PERSONAL INJURY AND PROPERTY DAMAGE.

This document and other information from Parker Hannifin Corporation, its subsidiaries and authorized distributors provide product or system options for further investigation by users having technical expertise.

The user, through its own analysis and testing, is solely responsible for making the final selection of the system and components and assuring that all performance, endurance, maintenance, safety and warning requirements of the application are met. The user must analyze all aspects of the application, follow applicable industry standards, and follow the information concerning the product in the current product catalog and in any other materials provided from Parker or its subsidiaries or authorized distributors.

To the extent that Parker or its subsidiaries or authorized distributors provide component or system options based upon data or specifications provided by the user, the user is responsible for determining that such data and specifications are suitable and sufficient for all applications and reasonably foreseeable uses of the components or systems.

OFFER OF SALE

The items described in this document are hereby offered for sale by Parker Hannifin Corporation, its subsidiaries or its authorized distributors. This offer and its acceptance by the provisions stated in the detailed 'Offer of Sale' which is available upon request.

Table of Contents

Topic		Page
Introduction	Introduction to Parker Hannifin	4
AC890	AC890 modular systems drive	5
	Specifications	8
	Connection Diagram	9
	Ratings	10
	Dimensions	15
Accessories and Options	Keypads, Communications, Feedback, Ventilation	16
	Software tools	23

Parker Hannifin

The global leader in motion and control technologies and systems

Global Partnerships Global Support

Parker is committed to helping make our customers more productive and more profitable through our global offering of motion and control products and systems. In an increasingly competitive global economy, we seek to develop customer relationships as technology partnerships. Working closely with our customers, we can ensure the best selection of technologies to suit the needs of our customers' applications.

Electromechanical Technologies for High Dynamic Performance and Precision Motion

Parker electromechanical technologies form an important part of Parker's global motion and control offering. Electromechanical systems combine high performance speed and position control with the flexibility to adapt the systems to the rapidly changing needs of the industries we serve.



About Parker Hannifin Corporation

Parker Hannifin is a Fortune 250 global leader in motion and control technologies. For more than a century the company has been enabling engineering breakthroughs that lead to a better tomorrow. Learn more at www.parker.com or [@parkerhannifin](https://twitter.com/parkerhannifin)



Modular Systems Drives

AC890 Systems Drive

1 HP - 500HP

Description

The AC890 is a compact, modular systems-capable drive engineered to control speed and position of open-loop and closed-loop, single- or multi-motor AC induction or PMAC motor applications.



Features

The AC890 can be configured for multiple modes of operation

Open-loop (volts/frequency) control

This mode is ideal for basic, single or multi-motor speed control.

Sensorless vector control

With its ultra high performance sensorless vector algorithm, the AC890 delivers a combination of both high torque and close speed regulation without the need for any speed measuring transducer.

Closed-loop vector control

Full closed-loop flux vector performance can be achieved with the AC890 by simply adding an encoder feedback 'technology box'. This provides 100% continuous full load standstill torque, plus a highly dynamic speed loop more than sufficient for the most demanding applications.

PMAC servo control

Allows the use of a PMAC motor such as the TMW series, with feedback device.

Compatible with a wide range of feedback options

The AC890 is compatible with any AC motor and virtually any speed/position feedback options. With this flexibility you may not even need to replace your existing AC motor to achieve high performance, saving you time and money.

- Incremental encoder
- EnDat 2.1 (SinCos) encoder
- Resolver

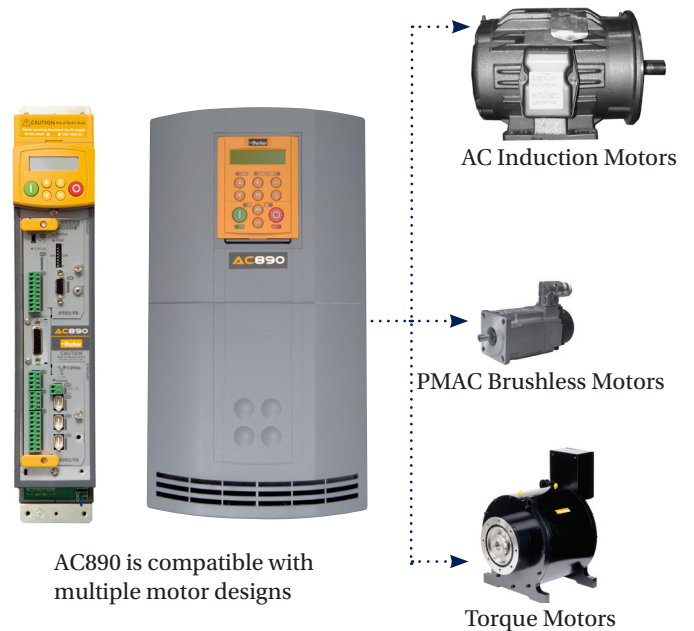

International Standards

Complies with:

- RoHS Directive 2011/65/EU
- EN61800-3 (EMC) Directive
- CE Marked to EN50178 (Low Voltage) Directive
- Units listed in this catalog are UL Listed to US safety standard UL508C and cUL Listed to Canadian standard C22.2 #14 except where otherwise noted.

Modular Systems Drives

AC890 Systems Drive

Features

Range of feedback options

- Incremental encoder
- EnDat® 2.1 (SinCos) encoder
- Resolver



Versatile communications

- Ethernet/IP
- Modbus/TCP
- LINKnet
- CANopen
- Profibus-DP
- Profinet/IO
- EtherCAT
- RS485
- DeviceNet
- ControlNet
- FireWire IEEE 1394
- USB port



Ultra-fast control loops

- Torque loop: 62.5µs
- Speed loop: 62.5µs
- Position loop: 62.5µs

Serves the most demanding applications

Taking advantage of leading edge control algorithms running on a fast 150 Mhz microprocessor, the AC890 drive can achieve very high bandwidth control loops. This allows you to use the drive for the most demanding industrial applications e.g. printing, cut-to-length, position synchronization, rotary shear, converting and slitting.

Benefits

Integrated safety functionality

The integrated Safe Torque Off (STO) functionality offers protection against unexpected motor start-up, in accordance to EN13849-1 PLe, SIL 3 as standard.

Minimal delay between fieldbus setpoints and the control loops

Designed to integrate in existing automation systems, the AC890 features high performance ports linked directly to the fast control loops of the drive. Minimum delay exists between your digital setpoint sent through a fieldbus and the control loops.

Replacement of analog solutions

Your existing analog setpoint-based solutions can be replaced by a digital fieldbus-based solution with minimum bandwidth loss.

Flexible feedback options

The AC890 offers system designers complete flexibility in their choice of feedback technology to best suit the needs of their application.

Open standards for protection of investment

The AC890 has been specifically designed to integrate seamlessly into your automation network. To connect to your PLC or fieldbus network you can simply choose from the wide range of communications options.

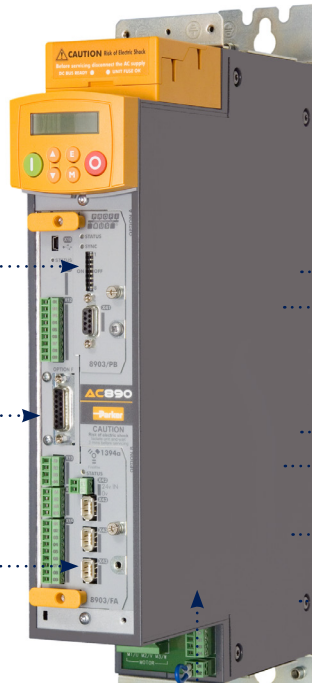

Modular Systems Drives

AC890 Systems Drive

Space saving compact footprint thanks to modular design concept

Stand Alone version (SD)



The Complete Drive

The AC890SD series Stand Alone version provides a complete AC input to AC motor output drive, with keypad and display included. Perfect solution for single motor applications where line regeneration is not required.

Characteristics of the AC890SD include:

- Power output up to 500 HP
- 208-500 VAC input supply
- Compatibility with all feedback and networking options
- Built-in dynamic brake switch with provision to add external braking resistor
- 24VDC control board supply for programming without power
- Torque and speed signal outputs
- USB programming port
- Operator keypad/display for programming, status, and diagnostics

Reduced dimensions, compact footprint

The AC890 has been designed to be compact and require the minimum possible cabinet space. Boasting the latest innovations in semiconductor cooling, the AC890 is a class leader in terms of its size.

Common Bus System (CS+CD)



Common Bus System

The AC890 is also available in a common bus platform, where multiple motor output drives (CD) are easily connected to a common DC bus supply (CS).

Characteristics of the common bus drive (AC890CD) :

- Power output to 150 HP in 5 frame sizes
- Power Supply : 320 to 705 VDC
- Compatibility with all feedback and networking options
- 24VDC control board supply for programming without power
- Torque and speed analog outputs
- USB programming port

Characteristics of the common bus supply module (AC890CS):

- Power output 25 to 135 HP
- Power Supply : 208-500 VAC
- Built-in dynamic braking unit (external braking resistor required)
- Operator display
- Up to 200ADC output per module

The control terminals are plug-in style, simplifying connection to the drive during installation and allowing a fast swap-out for maintenance purposes.

The Common DC bus also helps to keep the overall size of the system to a minimum. Simply open the bus terminal cover, connect the bus bars and close.

Removable terminal block connections for easier installation and maintenance



Fast connection of the common DC busbars



Modular Systems Drives

AC890 Systems Drive



Technical Specification

Power Supply	890CS : 208 - 500 VAC +/- 10 % 890CD : 320/560 - 705 VDC 890SD : 380 - 500 VAC +/- 10 % Frames E/F/G/H/J : 380 - 460 VAC +/- 10 %
Operating Temperature	0°-45°C (32°-113° F) - Frame B-F 0°-40°C (32°-104° F) - Frame G and above (derate by 2% per degree C up to 50°C maximum)
Altitude	Up to 1000m ASL (derate 1% per 100m to 2000m max)
Protection	IP20 (Frames G/H/J: IP00)
Humidity	Maximum 85% non-condensing
Analog Inputs	4; 12 bit, Configurable 2 x 0-10V, +/-10V, 0-20mA, 4-20mA and 2 x 0-10V, +/-10V (High resolution 15 bit plus sign analog input available with addition of 8903/AI option)
Analog Outputs	2; 12 bit, Configurable 0-10V, +/- 10V
Digital Inputs	7; Configurable 24VDC
Digital Output	2; Configurable 24VDC
Digital Relay Output	1; Configurable (Frames B-D) 4; Configurable (Frames E-J)
Communications Options	EtherNet/IP, Modbus/TCP, LINKnet, CANopen, PROFIBUS, PROFINET, DeviceNet, ControlNet, FireWire, EtherCAT, Peer to peer, RS485/Modbus
Axis Synchronisation	Internally via Firewire IEEE1394
Overload	Constant Torque Ratings: 150% for 60 sec Variable Torque Ratings: 110% for 60 sec Servo Mode: 200% for 4 sec
Output Frequency*	0-590 Hz - Volts/Hertz Mode 0-350 Hz - Closed Loop Vector Mode 0-120 Hz - Sensorless Vector Mode
Switching Frequency	Size B-D - 3 kHz (4 kHz or 8 kHz in servo mode) Size E - 3 kHz or 6 kHz Size F - 3 kHz Size G-H - 2.5 kHz Size J - 2 kHz Some exceptions may apply - see manual
Atmosphere	Non flammable, non corrosive and dust free

* Refer to factory for higher output frequencies

Safe Torque Off - STO

The AC890 features Safe Torque Off functionality **as standard**, offering users protection against unexpected motor start-up in accordance with EN18849-1 PL-e or SIL3. STO connections are made to X11 terminals per installation manual. (STO not present on frames G, H, and J)

To ensure a high degree of safety, two independent STO control channels are implemented in hardware. The circuit is designed such that a fault in one control channel will not affect the other channel's ability to prevent the drive from starting, i.e. the STO function of the is tolerant to any single fault. It may not be tolerant to an accumulation of faults. This is in keeping with its declared safety ratings.

STO always overrides any attempt to start the drive. If one or both STO control inputs is requesting the STO function, the drive will not start, even if for example, the drive's software malfunctions and tries to cause the motor to turn. The STO function is implemented in hardware; it overrides all software activities. The only software involvement is to report STO status to the user via an MMI, serial communications link or user terminal on the AC890 control board as defined by the drive configuration.

Note: STO is an electronic inhibit intended for use during normal operation of the machine. It is not intended for use during machine maintenance, repair, replacement or other similar activities. For these activities recognized electrical power isolation devices and lock-out procedures must be used.

Modular Systems Drives

AC890 Systems Drive



Connection Diagram

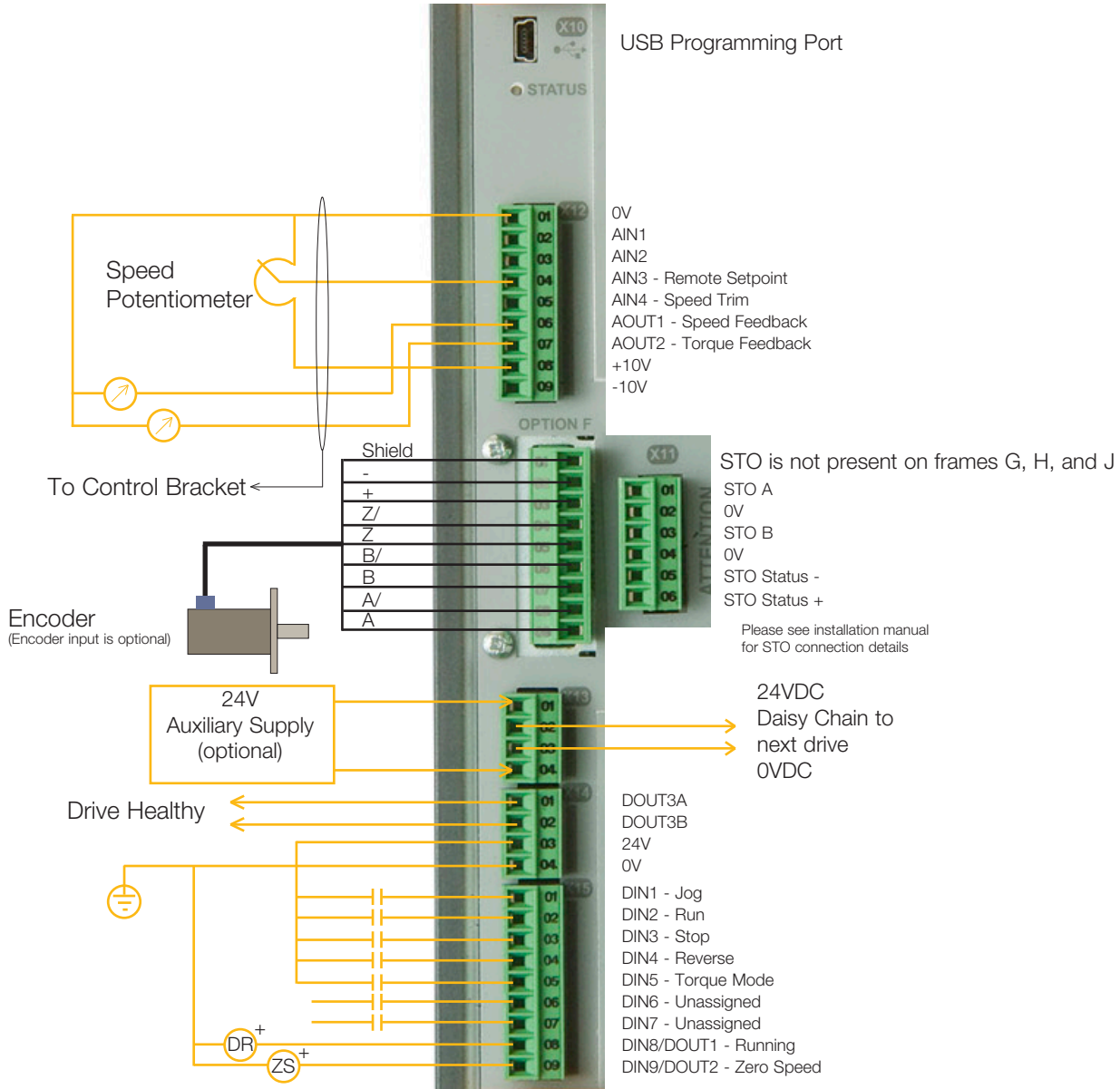

This diagram shows examples of some basic user connections to the Control Module. It is not intended to be a substitute for the installation manual which is provided with each drive and available for download on the website.

DC Power Supply Module

AC890CS Module

10 HP - 135 HP (40A - 200A)



Description

Used in common bus systems, the AC890CS (Common Supply) module is able to provide DC bus voltage to one or more AC890CD units. Inter-connecting busbar is available from Parker. This modularity provides significant space saving in the enclosure. For 12 pulse or 18 pulse input, multiple CS modules may be used.

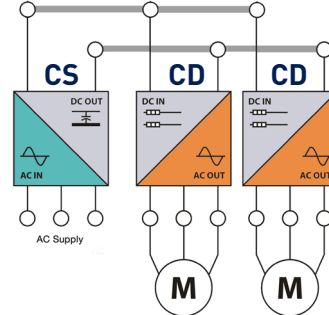

DC Power Supply

Use with AC890CD for a common bus system

208-500VAC Input

Built-in dynamic braking switch

DC bus power output terminals

Operator display for diagnostics

CS Module Includes:

“Drive Healthy” contact

24VDC auxiliary supply (optional)

HMI Interface

Power supply selector

Configurable analog outputs

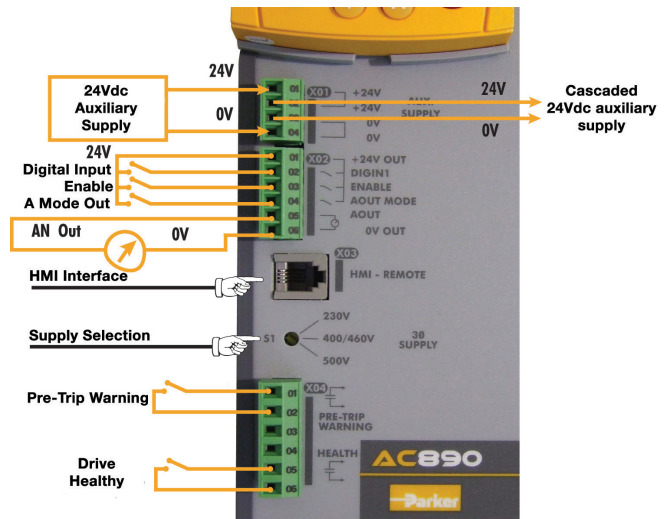

Electrical Characteristics - AC890CS Drives

Part Number	Frame	Input voltage (VAC)	Power (HP)	Power (kW)	AC input current (A)	DC output current (A)
890CS/5/0032B/B/00/N/EN	B	230	10	7.5	32	40
		400/460	25	15		
890CS/5/0054B/B/00/N/EN	B	230	20	15	54	65
		400/460	45	30		
890CS/5/0108D/B/00/N/EN	D	230	40	30	108	135
		400/460	90	60		
890CS/5/0162D/B/00/N/EN	D	230	60	45	162	200
		400/460	135	90		

kW power ratings correspond to 400 VAC input

Note: For increased power, additional units can be connected in parallel.

For further details, contact our technical support department



Modular AC Systems Drives

AC890CD Series Systems Drive

1 HP - 150 HP (1.5A - 180A)



Description

Used in common bus systems, the AC890CD (Common Drive) module accepts DC input from an AC890CS unit. Multiple CD units may be connected to a single CS. Interconnecting busbar is available from Parker. This modularity provides significant space saving in the enclosure. Typical applications include printing, converting, or other continuous web processes.

DC Input

Power Supply 320, 650, 705VDC

Use with AC890CS for a common bus system

Operator display supplied as standard

Common options as AC890SD

Electrical Characteristics - AC890CD Drive

Part Number	Frame	CS Module Voltage	Constant Torque			Variable Torque			Servo		Features
			Power (HP/kW)	Output Current (A)		Power (HP/kW)	Output Current (A)		Output Current (A)		
				208 or 380	230 or 460		208 or 380	230 or 460	208 or 380	230 or 460	
890CD/2/0005B/N/00/A/US	B	208/230	1.5/1.1	5.5	5.5	1.5/1.1	5.5	5.5	4	4	Internal Fusing
890CD/2/0007B/N/00/A/US		208/230	2/1.5	7	7	2/1.5	7	7	6	6	Internal Fusing
890CD/2/0016B/N/00/A/US		208/230	5/4	16.5	16.5	5/4	16.5	16.5	12	12	Internal Fusing
890CD/2/0024C/N/00/A/US	C	208/230	7.5/5.5	24	24	7.5/5.5	24	24	24	24	Internal Fusing
890CD/2/0030C/N/00/A/US		208/230	10/7.5	30	30	10/7.5	30	30	30	30	Internal Fusing
890CD/5/0002B/N/00/A/US	B	380/500	1/0.55	2	2	1/0.55	2	2	1.5	1.5	Internal Fusing
890CD/5/0003B/N/00/A/US		380/500	1.5/1.1	3.5	3.5	1.5/1.1	3.5	3.5	2.5	2.5	Internal Fusing
890CD/5/0004B/N/00/A/US		380/500	2/1.5	4.5	4.5	2/1.5	4.5	4.5	3.5	3.5	Internal Fusing
890CD/5/0006B/N/00/A/US		380/500	3/2.2	5	6	3/2.2	5	5	4	4	Internal Fusing
890CD/5/0010B/N/00/A/US		380/500	5/4	8	10	5/4	8	8	6	6	Internal Fusing
890CD/5/0012B/N/00/A/US		380/500	7.5/5.5	12	12	7.5/5.5	12	12	9	9	Internal Fusing
890CD/5/0016B/N/00/A/US		380/500	10/7.5	14	16	10/7.5	14	16	10	12	Internal Fusing
890CD/5/0024C/N/00/A/US	C	380/500	15/11	24	24	15/11	24	24	20	20	Internal Fusing
890CD/5/0030C/N/00/A/US		380/500	20/15	27	30	20/15	27	30	22	25	Internal Fusing
890CD/5/0039D/N/00/A/US	D	380/500	25/18.5	35	39	25/18.5	35	39	29	35	Internal Fusing
890CD/5/0045D/N/00/A/US		380/500	30/22	40	45	30/22	40	45	34	38	Internal Fusing
890CD/5/0059D/N/00/A/US		380/500	40/30	52	59	40/30	52	59	45	50	Internal Fusing
890CD/4/0073E/N/00/A/US	E	380/500	50/37	73	73	60/45	87	87	73	73	Requires DC Fusing
890CD/4/0087E/N/00/A/US		380/500	60/45	87	87	75/55	105	105	87	87	Requires DC Fusing
890CD/4/0145F/N/1F/A/US	F	500/380	100/75	130	145	125/90	156	165	99	110	Requires DC Fusing
890CD/4/0156F/N/1F/A/US*		500/380	125/90	156	180	150/110	180	205	117	135	Requires DC Fusing
890CD/4/0180F/N/1F/A/US*		500/380	150/90	180	180	N/A	N/A		135	135	Requires DC Fusing

* 890CD/4/0156F/... and 890CD/4/0180F/... are not UL or cUL listed

Note : For higher powers, refer to AC890SD series supplied from a DC bus.
 Servo current ratings assume 4kHz switching frequency.
 Servo overload ratings: Frame B-D - 200% for 4 sec., Frame E-F - 150% for 60 sec.

Modular AC Systems Drives

AC890SD Series Systems Drive

0.75 HP - 500 HP



Description

The AC890SD (Standalone) drives are independent modules with integrated three-phase AC supply inputs. With its wide range of sizes available, the AC890SD is suitable for every type of application from a small machine to a large industrial high power process line. For variable torque loads like fans, blowers, and most pumps, economical “VT” ratings are offered for Frame E and larger.

- AC Input or DC common bus**
- Built-in dynamic braking module**
- Operator display provided as standard**

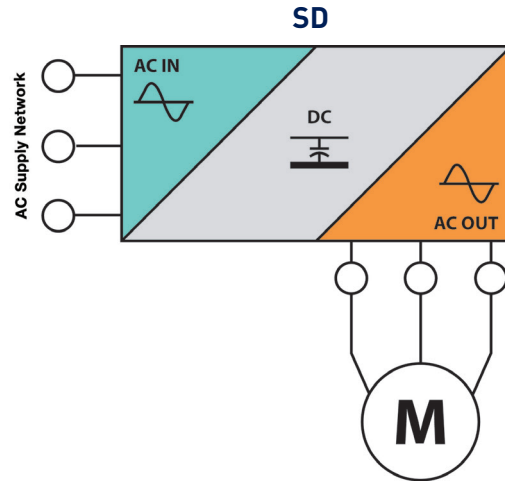

Electrical Characteristics - AC890SD Drive - 230V

Part Number	Frame	Input Voltage (VAC)	Power CT or VT (HP/kW)	CT or VT Output Current (A)	Servo Output Current (A)
890SD/2/0005B/B/00/A/US	B	230	1.5/1.1	5.5	4
890SD/2/0007B/B/00/A/US			2/1.5	7	6
890SD/2/0011B/B/00/A/US			3/2.2	11	8
890SD/2/0016B/B/00/A/US			5/4	16.5	12
890SD/2/0024C/B/00/A/US	C	230	7.5/5.5	24	24
890SD/2/0030C/B/00/A/US			10/7.5	30	30

Note : All SD units above include brake module.

Permitted overload : 150% for 60 sec in vector mode - 200% for 4 sec in servo mode.

Modular AC Systems Drives

AC890SD Series Systems Drive

0.75 HP - 500 HP

Electrical Characteristics - AC890SD drive (contd.)

Part Number	Frame	Input voltage (VAC)	Constant Torque			Variable Torque			Servo		Inductance
			Power (HP/kW)	Output Current (A)		Power (HP/kW)	Output Current (A)		Output Current (A)		
				400V	460V		400V	460V	400V	460V	
890SD/5/0002B/B/00/A/US	B	380-460	0.75/0.55	2	2	0.75/0.55	2	2	1.5	1.5	
890SD/5/0003B/B/00/A/US			1.5/1.1	3.5	3.5	1.5/1.1	3.5	3.5	2.5	2.5	
890SD/5/0004B/B/00/A/US			2/1.5	4.5	4.5	2/1.5	4.5	4.5	3.5	3.5	
890SD/5/0006B/B/00/A/US			3/2.2	5	5	3/2.2	5	5	4	4	
890SD/5/0010B/B/00/A/US			5/4	8	8	5/4	8	8	6	6	
890SD/5/0012B/B/00/A/US			7.5/5.5	12	12	7.5/5.5	12	12	9	9	
890SD/5/0016B/B/00/A/US			10/7.5	14	16	10/7.5	14	16	10	12	
890SD/5/0024C/B/00/A/US	C	380-500	15/11	24	24	15/11	24	24	20	20	
890SD/5/0030C/B/00/A/US			20/15	27	30	20/15	27	30	22	25	
890SD/5/0039D/B/00/A/US	D	380-500	25/18.5	35	39	25/18.5	35	39	29	35	
890SD/5/0045D/B/00/A/US			30/22	40	45	30/22	40	45	34	38	
890SD/5/0059D/B/00/A/US			40/30	52	59	40/30	52	59	45	50	
890SD/4/0073E/B/00/A/US	E	380-460	50/37	73	73	60/45	87	87	73	73	
890SD/4/0087E/B/00/A/US			60/45	87	87	75/55	105	105	87	87	
890SD/4/0105F/B/1F/A/US	F	380-460	75/55	100	105	100/75	125	145	74	78	
890SD/4/0145F/B/1F/A/US			100/75	130	145	125/90	156	165	99	110	
890SD/4/0156F/B/1F/A/US			125/90	156	180	150/110	180	205	117	135	
890SD/4/0180F/B/1F/A/US			150/110	180	180	150/90	180	205	135	135	
890SD/4/0250G/N/1F/A/US	G	380-460	200/132	250	250	250/150	302	302	171	171	
890SD/4/0250G/B/1F/A/US			200/132	250	250	250/150	302	302	171	171	
890SD/4/0361G/N/1F/A/US			300/180	361	361	350/220	420	420	253	253	
890SD/4/0361G/B/1F/A/US			300/180	361	361	350/220	420	420	253	253	
890SD/4/0420H/N/1F/A/US	H	380-460	350/220	420	420	400/250	480	480	300	300	
890SD/4/0420H/B/1F/A/US			350/220	420	420	400/250	480	480	300	300	
890SD/4/0520H/N/1F/A/US			450/280	520	520	500/315	590	590	368	368	
890SD/4/0520H/B/1F/A/US			450/280	520	520	500/315	590	590	368	368	
890SD/4/0590J/N/1F/A/US	J	380-460	500/315	590	590	550/355	650	650	411	411	
890SD/4/0590J/B/1F/A/US			500/315	590	590	550/355	650	650	411	411	

Permitted overload : 150% for 60 sec in vector mode
 Servo current ratings assume 4kHz switching frequency.
 Servo overload ratings: Frame B-D - 200% for 4 sec., Frame E-F - 150% for 60 sec.

Modular AC Systems Drives

AC890 Alternative Input Power Configurations

0.75 HP - 360 HP

The modular design of the AC890 makes it easy to connect parallel input (CS) modules for multi-phase configurations. By using 12-pulse or 18-pulse configurations, harmful line harmonics can be greatly reduced. Or, for the ultimate in harmonic abatement, an Active Front End (AFE) may be selected.

The typical AC drive has six rectifiers in a three phase bridge configuration, and is commonly referred to as a “6-pulse” configuration. A 12-pulse drive configuration contains two sets of six rectifiers, an 18-pulse configuration, three sets of six rectifiers and so on. If the AC power connected to each set of rectifiers is “phase shifted”, then some of the harmonics produced by one set of rectifiers will be opposite in polarity from the harmonics produced by the other set of rectifiers. The two (or three) wave forms effectively cancel each other out. To provide the phase shifted AC power, a special transformer with multiple secondary windings is specified.



12 Pulse Transformer Configuration

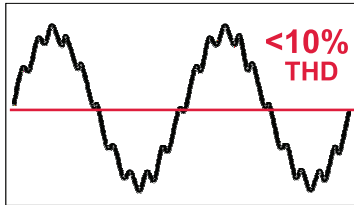

Input Current Waveform

12 pulse connection (option)	CS Modules Required	2
	Harmonics	Under 10% THD
	Input Transformer	User supplied - Delta primary, Wye and Delta secondaries, 30 degree phase shift.

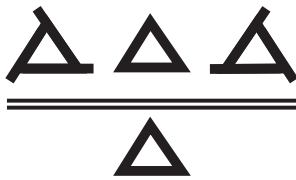

18 Pulse Transformer Configuration

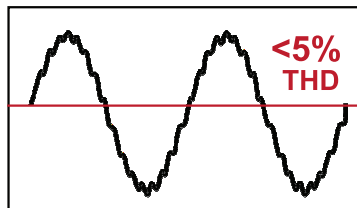

Input Current Waveform

18 pulse connection (option)	CS Modules Required	3
	Harmonics	Under 5% THD
	Input Transformer	User supplied - Delta primary, three secondaries, 20 degree phase shift.

Dimensions

AC890 Series Systems Drives

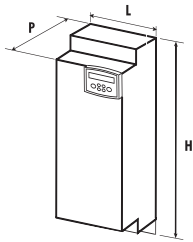

Frames B/C/D

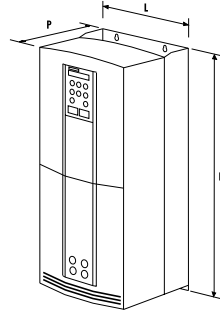

Frames E/F

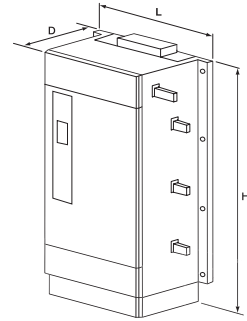

Frames G/H/J

Dimensions and Weights

Model	H (in/mm)	W (in/mm)	D (in/mm)	Weight (lb/kg)			
				AC890CS	AC890CD	AC890SD	
AC890 Frame B	17.0/433	2.85/72.4	10.16/258	7.7/3.5	11.0/5	13.2/6	
AC890 Frame C		4.57/116		N/A	14.6/6.6	16.8/7.6	
AC890 Frame D		6.30/160		19.2/8.7	26.7/12.1	28.9/13.1	
AC890 Frame E	26.3/668	10.12/257	12.28/312	N/A	71.7/32.5	73.9/33.5	
AC890 Frame F	28.35/720		13.98/355		90.4/41	92.6/42	
AC890 Frame G	41.0/1042	17.95/456	18.31/465		N/A	N/A	238/108
AC890 Frame H	46.34/1177	22.52/572					304/138
AC890 Frame J	50.71/1288	26.57/675		388/176			

Accessories

AC890 Series



Operator Interface

Model	Description
6511/TTL/00	4 Digit LCD keypad*
6901/00/G	Alphanumeric multilingual keypad**
6052/00	Remote mounting kit for 6901 with 3m cable

*Standard equipment for frames B - D

** Standard equipment for frames E - K



6511/TTL/00



6901/00/G

Keypad Blanking Cover

The keypad blanking cover kit may be used when local keypad is not installed.

Kit includes light pipes for LEDs.



Part Number	Description	Suitable for
BD467732U002	Blank Cover	AC890 Frame B-D
LA500326U001		AC890 Frame E-J

Common Bus System

Model	Description
BH465850	1 meter DC Rail/Bus Bar, copper 140A
BC465938U200	Insulator for DC bus bars 200mm
BA469216	1 meter Grounding bus bar
890CA/5/0050B/N/00/N/EN	Common bus adapter, 50A, w/bus capacitors
890CA/5/0080B/N/00/N/EN	Common bus adapter, 80A, w/o bus capacitors

Cables

Model	Description
CM471050	USB programming cable for AC890
8905/FWCBL200/00	FireWire cable 200 mm (B frame to B, C, D frame)
8905/FWCBL280/00	FireWire cable 280 mm (C, D frame to B, C, D frame)
8905/FWCBL1000/00	FireWire cable 1000 mm (Rack to rack)
8905/FWCBL4500/00	FireWire cable 4.5 m (Rack to rack to enclosure)

Options

AC890 Series

Communication Interfaces



Ethernet/IP (8903/IP/00)

Supported Protocols	Ethernet IP, Level 2 I/O Server CIP
Communication speed	10/100Mbps/s
Station Address	By DSE software via RTNX protocol
Connection support	4 class 1 (cyclic I/O data transfer), 16 class 3 (explicit messaging)
Interface	RJ45 CAT-5 or higher
Suitable for Drives	AC890 firmware version 3.2+

Modbus/TCP (8903/IM/00)

Communication speed	10/100Mbps/s
Station Address	By DSE software via RTNX protocol
Connection support	Up to 4 simultaneous connections
Interface	RJ45 CAT-5 or higher
Suitable for Drives	AC890 firmware version 3.2+

EtherCAT (8903/CT/00)

Supported Protocols	CANopen over EtherCAT (CoE)
Communication speed	100M bits/s
Features	DS301 compliant, EMCY support
Interface	RJ45 in/RJ45 out CAT-5 or higher
Suitable for Drives	AC890 firmware version 3.7+

DeviceNet (8903/DN/00)

Supported Protocols	Supports the group 2 only slave subset of the DeviceNet protocol
Supported Messages	Polled I/O, Cyclic Outputs, Change of State (COS), Explicit Messaging
Communication Speed	125K, 250K et 500K bits/s
Station Address (MACID)	DIP switch or software setting of station address and network speed
Interface	5-position removeable terminal strip
Suitable for Drives	AC890 firmware version 1.9+

ControlNet (8903/CN/00)

Supported Messages	Polled I/O
Station Address	Selectable by DSE software or hardware switches
Data capacity	Up to 504 bytes of producer data and 504 bytes of consumer data
Interface	2 Co-axial RG-6 connectors (channel A, B), RJ45 network access port
Suitable for Drives	AC890 firmware version 1.4+

Profinet/IO (8903/PN/00)

Supported Protocols	Profinet I/O Real-time (RT) Protocol
Communication speed	100Mbps/s
Station Address (IP)	Software setting of IP address via DSE
Interface	RJ45 CAT-5 or higher
Suitable for Drives	AC890 firmware version 3.3+

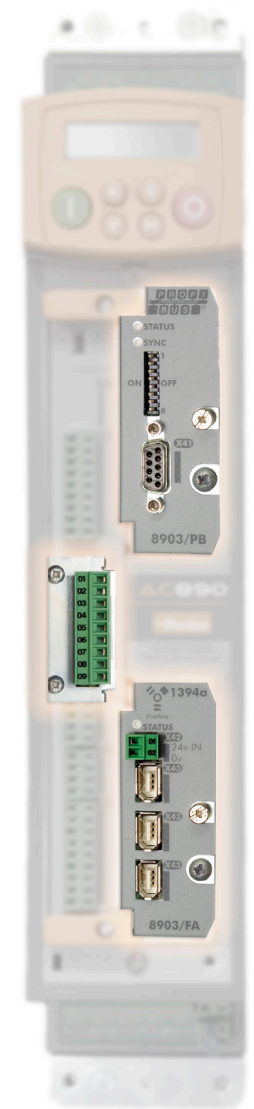

**Plug-in Design
for easy field
installation of all
feedback and I/O
options.**

Options

AC890 Series

Communication Interfaces



FireWire IEEE 1394 (8902/FA/00)

Communication Supported	Peer-to-Peer communication between drives via IEEE1394 standard
Communication Speed	Up to 400 MBaud
LA471480	Firewire Repeater Kit - includes 100 ft. CAT5 cable
Interface	3 IEEE1394a Firewire ports, removable terminal strip for 24V power input
Suitable for Drives	All AC890

RS485/Modbus (8903/RS/00)

Supported Protocols	Slave Modbus RTU
Communication Speed	1200 to 115200 bits/second
Interface	RS485 2 wire
Station Address	Selectable via software
Suitable for Drives	AC890 firmware version 3.7+

CANopen (8903/CB/00)

Profile	DS402
Supported Messages	SDO, PDO, NMT, SYNC
Communication Speed	20K, 50K, 125K, 250K, 500K, 1Mbits/s selectable by software or DIP switch setting
Station Address	DIP switch or software setting of station address
Interface	5-position removable terminal strip
Suitable for Drives	AC890 firmware version 1.3+

Profibus-DP (8903/PB/00)

Supported Protocols	Profibus-DP ; Demand Data and Data Exchange
Communication Speed	Up to 12M bits/s selected by the master
Station Address	DIP switch or software setting of station address
Interface	9-pin D-sub connector
Suitable for Drives	AC890 firmware version 1.4+

LINKnet (8903/LN/83)

Supported Protocols	Ethernet I/P, Modbus TCP/IP, Modbus UDP/IP, Peer-to-peer communications between AC890 drives
Communication Speed	100 MBs
Station Address	By DSE software
Interface	RJ45 CAT-6 shielded
Suitable for Drives	AC890 firmware version 3.13

Note: Part numbers above refer to option cards provided loose for field installation.

Options

AC890 Series

Feedback cards

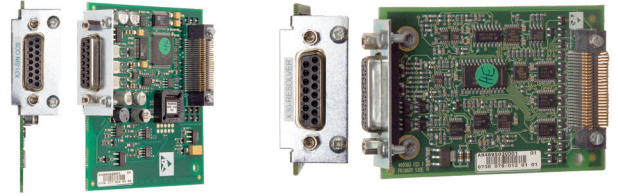

8902/RE/00 - Resolver

The 8902/RE resolver speed feedback option allows the resolver to be connected directly to the drive to provide highly accurate speed feedback measurement. Contains a carrier output signal to power the resolver.

Part Number	Description
8902/RE/00/00	Optional Resolver feedback card

Features

Maximum Speed	Up to 50,000 RPM (with 2 pole resolver)
Carrier Output Signal	7V rms, 8kHz
Maximum Carrier Supply	70mA rms
Maximum Input Voltage	±12V peak
Accuracy	< 5 minutes
Resolution	Equivalent to 16 bits in one revolution of resolver
Inputs	Differential inputs Zin ~2 kΩ
Maximum Input Voltage	12V peak

8902/M1/00 - Sin/Cos Encoder

The Sin/Cos Registration Option allow 1 Volt peak-to-peak Sin/Cos encoders to be connected directly to the motor controller to provide highly accurate speed feedback measurement and position. It may be used in conjunction with 8903/M1 for systems requiring two simultaneous encoder inputs.

Part Number	Description
8902/M1/00/00	Optional encoder feedback card

Features

Maximum Pulse Rate	250kHz
Receiver Impedance	120Ω
Input Format	2 differential 1V p-p signals in quadrature
Encoder Supply	250mA maximum load
Supply Voltage	5V/10V adjustable
Terminal Type	15 pin D-Sub connector
Maximum Cable Length	150m shielded cable
Serial Protocol	Endat 2.1

8902/EQ/00 - HTTL Encoder

The HTTL 8902/EQ speed feedback option allows incremental encoders to be connected directly to the drive to provide highly accurate speed feedback measurement. Supplies variable voltage isolated encoder power supply.

Part Number	Description
8902/EQ/00/00	Optional HTTL incremental encoder

Features

Maximum pulse rate	250kHz (differential) 200kHz (single ended)
Receiver current	≤10mA per channel
Input Format	Two differential channels in quadrature (Clock/direction or clock only)
Input Voltage	±30V (differential), 0-30V (single-ended)
Input Voltage Differential	±30V maximum
Input Voltage Threshold	3V ± 1V (differential) 8V ± 1V (single-ended)
Encoder Power Supply	Maximum load 200mA or 2W Voltage adjustable 10V to 20V by firmware

Options

AC890 Series I/O Cards

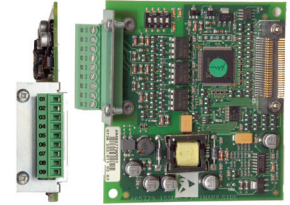

8903/EP/00 - Encoder Input

The 8903/EP encoder input option allows an incremental encoder input as a reference, and provides a synthesized encoder output. The input features optically isolated differential inputs for channels A, B and Z. All inputs are compatible with RS422 and RS485 encoders, as well as encoders that provide output voltages as high as +/-30V. All decoding logic required to interface the encoder input to the drive is provided. Three non-isolated differential digital outputs are used for synthesizing an encoder output. Installed along with an 8902-EQ incremental encoder option, the board can be used to create an electronic line shaft between the reference and feedback encoders.

Part Number	Description
8903/EP/00/00	Optional Encoder Input card

8903/AI/00 - Hi-Res Analog Input

The 8903/AI card adds a high resolution analog input to the drive. In addition to all of the features and functionality of the 8903/EP encoder option board above, the 8903/AI includes a 15 bit plus sign +/-10V analog input. This makes the drive suitable for applications, where the drive follows a precision analog speed set point from a CNC and send back to the CNC the position of the controlled axis. It provides the fast response times required for accurate position control.

Part Number	Description
8903/AI/00/00	Optional High Resolution Analog Input and Encoder Input card

Features

Encoder Input	8903/EP and 8903/AI
Maximum Pulse Rate	250kHz
Receiver Current	≤10mA per channel
Input Format	Two differential channels in quadrature, clock/dir or clock only
Input Voltage Range	±30V (differential) 0-30V (single-ended) or RS422/485
Input Voltage Threshold	< 2V (differential) 8V ± 1V (single-ended)
Synthesized Encoder Output	8903/EP and 8903/AI
Supply Voltage	30V
Operating Input Supply Voltage (VS)	5V to 24V Absolute Maximum
Maximum Output Frequency	250kHz on each output
Maximum Output Current	± 100mA per output
Output Voltage	Low logic level < 3V @ 100mA High logic level > VS – 4V @ 100mA
Overload and short circuit duration	Indefinite
Maximum cable length *	150 meters
Analog Input	8903/AI Only
Resolution	15 bits + sign
Input voltage range	+/- 10V
Input Format	Differential
Input Impedance	100k-ohm
Input low pass filter	3kHz

Plug-in Design
for easy field
installation of all
feedback and I/O
options.

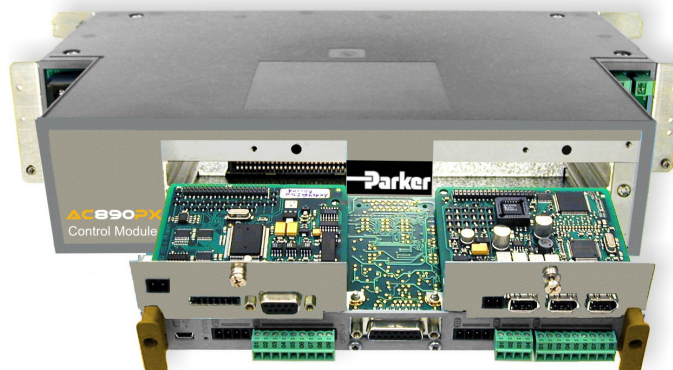

Options

AC890 Series

Sin/Cos encoder options

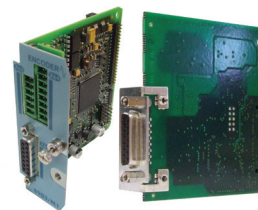

8903/M1/00, 8902/M1/00

Description

- Interpolates each encoder line with 11-bit accuracy giving 4 million counts/rev. on a 2048 line encoder
- Optional 1 V input from 'Z' index pulse
- Supplies 5V or 10V to the encoder
- Decodes Heidenhain Endat 2.1 absolute position encoders
- 4 optically isolated auxiliary digital outputs
- 3 non-isolated auxiliary digital outputs that can be either for general purpose outputs or for synthesizing an encoder output (8903/M1 only)

Part Number	Description
8902/M1/00	Slave SinCos feedback
8903/M1/00	Master SinCos feedback

Approved Encoders	1V p-p	Endat 2.1	Single Turn ABS	Multi-turn ABS
Heidenhain :				
EQN425	√	√		√
ECN413	√	√	√	
ERN480	√			

Specification

Encoder Inputs (8902/M1 and 8903/M1)

Maximum Pulse Rate	250kHz
Receiver Impedance	120Ω
Input Format	2 differential 1V p-p signals in quadrature
Encoder Supply	250mA maximum load
Supply Voltage	5V/10V adjustable
Terminal Type	15 pin D-Sub connector
Maximum Cable Length	150m screened cable
Serial Protocol	Endat 2.1

Auxiliary digital input (8903/M1 only)

Low Logic Level	0V to 5V relative to X63 pin 5
High Logic Level	15V to 26V relative to X63 pin 5
Absolute Max. Input Voltage	30V relative to X63 pin 5
Input Current	Low logic level < 1mA High logic level > 3mA, < 10mA Typical input at 24V : 7mA
Isolation withstand relative to drive chassis	30V
Input Safety Category	SELV
Terminal Type	6-way pluggable 3.5mm terminal block
Maximum Cable Length	150m screened cable is recommended for all lengths, but essential if over 30m in order to comply with EMC regulations

Auxiliary digital outputs (8903/M1 only)

Input Voltage (VS)	5V to 24V
Maximum Input Voltage	30V
Maximum Output Current	± 100mA per output
Output Voltage	Low logic level < 3V to 100mA High logic level > VS - 4V to 100mA
Overload and short circuit duration	Indefinite withstand
Max. Output Frequency	250kHz per output
Terminal Type	8-way pluggable 3.5mm terminal block
Maximum Cable Length	150m screened cable is recommended for all lengths, but essential if over 30m in order to comply with EMC regulations

Accessories

AC890 Series



Ventilation Components

Building your own system enclosure? Let Parker provide the necessary pre-engineered hardware to save you time and expense. Our installation kits and components come with guaranteed compatibility with the AC890 drives. All from a single source: Parker Electromechanical and Drives Division.

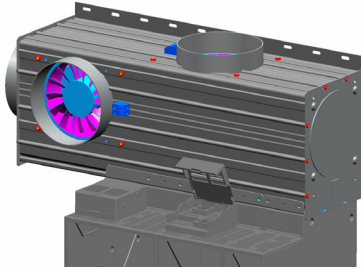

AC890 air ducting components make easy work of cabinet building when force ventilation is to be used. The exhaust duct, supplied in 1 meter sections, is mounted to the top of the AC890 heatsinks and includes a 190 CFM fan. This arrangement provides a very effective means of cooling by drawing air directly through the drives' heat sinks and out of the air outlets which can be flex-ducted out of the cabinet. See part numbers in table to right.

Part Number	Description
8905/DUCTKIT/00	Ventilation duct kit, 1 meter exhaust duct, one 190 CFM fan kit. Frame B-D
8905/DUCTFAN/00	Ventilation duct fan, 190 CFM, with flange (additional or replacement fan for duct kit)
LA466717U004	Exhaust duct kit, Frame E
LA466717U003	Exhaust duct kit, Frame F
VM15	Breakout Module - Dsub 15 to DIN rail terminal strip

Dynamic Braking

A range of braking resistor kits are available to complement the AC890CS and AC890SD modules that have brake modules installed. Braking resistor kits include the resistor with expanded sheet metal cage and overload.

Line Reactors

Parker's range of reactors can be used on either the input or output sides of the drive. They are used to add inductance to reduce the harmonic content of the supply current. A reactor installed in the drive output limits the capacitive current when motor cable runs in excess of 50m are used, preventing overcurrent trips and temperature rise of the motor.

In addition to helping with compliance with IEEE 519 there are other benefits to using line/load reactors including:

- Increased drive system reliability
- Reduced harmonics / surge currents
- Reduced motor noise and temperature
- Improved true power factor

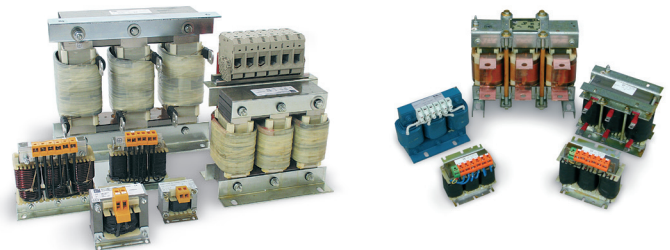

Software Tools

For All Drives with communications

Drive System Explorer Software

DSE is the programming, monitoring and diagnostic software platform for most Parker drives. Thanks to the on-line help, users can achieve the optimum drive configuration without the need to navigate through complicated parameter menus. Advanced programming is carried out through a set of pre-engineered templates in order to create the required configuration. It is possible to monitor every parameter of the drive either as a digital value or as a function in the “chart recorder” during normal operation.

While the drive is in running mode the oscilloscope function allows “on-line” monitoring of selected parameters and the recording of trends. Using straightforward block programming, DSE allows the user to create, parameterize and configure user defined applications thanks to function blocks dedicated to speed control, inputs, outputs, ramps, winder functions, PID, diameter calculator, and more. Groups of function blocks can be combined into macros for more complex programs.

There are three levels of DSE software:

- **DSE-Lite**, a free download, supports all of the functionality of the AC890 except peer to peer communications based systems using either Firewire 1394a or LINKnet.
- **DSE-Development** has all the DSE-Lite capabilities plus it enables the user to configure a multi-drive system using LINKnet or Firewire 1394a peer to peer communications as a single project. This includes programming and monitoring all drives from any point on the network.
- **DSE-Runtime** has all the capability of DSE-Development with the exception of being able to add a node to a system. It is intended as a maintenance tool for end users. (restricting the addition of a new node effectively prevents creation of a new system)

System Requirements

- Windows® 7 through Windows® 10, 32 or 64 bit operating system
- 100Mb of free hard disk space
- USB port for connecting to an AC890 or AC890PX drive
- Serial port for connecting to AC650V, AC690+, DC590+, or legacy drives.

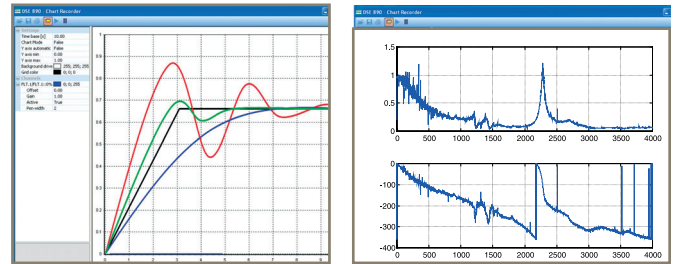

Real-time data acquisition and oscilloscope functions

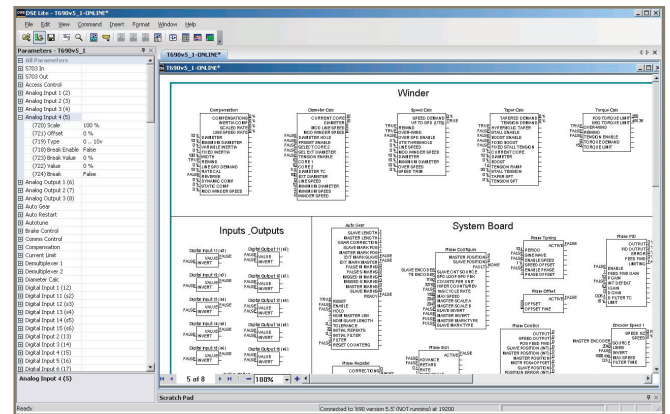

Function block configuration



Chart recorder function

Part Number	Description
DSE-Lite	DSE Lite software (single axis) + USB cable*
8906-DSEDEV-00	DSE Development software + USB cable
8906-DSERUN-00	DSE Runtime/Maintenance + USB cable
8906/DSEDEVUPG/00	DSD Development to DSE Development Upgrade + USB cable
8906/DSERUNUPG/00	DSD Runtime to DSE Runtime Upgrade + USB cable

* DSE Lite may also be downloaded free of charge at www.parker.com/ssdusa/software

Parker Worldwide

AE – UAE, Dubai

Tel: +971 4 8127100
parker.me@parker.com

AR – Argentina, Buenos Aires

Tel: +54 3327 44 4129

AT – Austria, Wiener Neustadt

Tel: +43 (0)2622 23501-0
parker.austria@parker.com

AT – Eastern Europe, Wiener Neustadt

Tel: +43 (0)2622 23501 900
parker.easteurope@parker.com

AU – Australia, Castle Hill

Tel: +61 (0)2-9634 7777

AZ – Azerbaijan, Baku

Tel: +994 50 2233 458
parker.azerbaijan@parker.com

BE/LU – Belgium, Nivelles

Tel: +32 (0)67 280 900
parker.belgium@parker.com

BR – Brazil, Cachoeirinha RS

Tel: +55 51 3470 9144

BY – Belarus, Minsk

Tel: +375 17 209 9399
parker.belarus@parker.com

CA – Canada, Milton, Ontario

Tel: +1 905 693 3000

CH – Switzerland, Etoy

Tel: +41 (0)21 821 87 00
parker.switzerland@parker.com

CL – Chile, Santiago

Tel: +56 2 623 1216

CN – China, Shanghai

Tel: +86 21 2899 5000

CZ – Czech Republic, Klecany

Tel: +420 284 083 111
parker.czechrepublic@parker.com

DE – Germany, Kaarst

Tel: +49 (0)2131 4016 0
parker.germany@parker.com

DK – Denmark, Ballerup

Tel: +45 43 56 04 00
parker.denmark@parker.com

ES – Spain, Madrid

Tel: +34 902 330 001
parker.spain@parker.com

FI – Finland, Vantaa

Tel: +358 (0)20 753 2500
parker.finland@parker.com

FR – France, Contamine s/Arve

Tel: +33 (0)4 50 25 80 25
parker.france@parker.com

GR – Greece, Athens

Tel: +30 210 933 6450
parker.greece@parker.com

HK – Hong Kong

Tel: +852 2428 8008

HU – Hungary, Budapest

Tel: +36 1 220 4155
parker.hungary@parker.com

IE – Ireland, Dublin

Tel: +353 (0)1 466 6370
parker.ireland@parker.com

IN – India, Mumbai

Tel: +91 22 6513 7081-85

IT – Italy, Corsico (MI)

Tel: +39 02 45 19 21
parker.italy@parker.com

JP – Japan, Tokyo

Tel: +81 (0)3 6408 3901

KR – South Korea, Seoul

Tel: +82 2 559 0400

KZ – Kazakhstan, Almaty

Tel: +7 7272 505 800
parker.easteurope@parker.com

LV – Latvia, Riga

Tel: +371 6 745 2601
parker.latvia@parker.com

MX – Mexico, Apodaca

Tel: +52 81 8156 6000

MY – Malaysia, Shah Alam

Tel: +60 3 7849 0800

NL – The Netherlands, Oldenzaal

Tel: +31 (0)541 585 000
parker.nl@parker.com

NO – Norway, Ski

Tel: +47 64 91 10 00
parker.norway@parker.com

NZ – New Zealand, Mt Wellington

Tel: +64 9 574 1744

PL – Poland, Warsaw

Tel: +48 (0)22 573 24 00
parker.poland@parker.com

PT – Portugal, Leca da Palmeira

Tel: +351 22 999 7360
parker.portugal@parker.com

RO – Romania, Bucharest

Tel: +40 21 252 1382
parker.romania@parker.com

RU – Russia, Moscow

Tel: +7 495 645-2156
parker.russia@parker.com

SE – Sweden, Spånga

Tel: +46 (0)8 59 79 50 00
parker.sweden@parker.com

SG – Singapore

Tel: +65 6887 6300

SK – Slovakia, Banská Bystrica

Tel: +421 484 162 252
parker.slovakia@parker.com

SL – Slovenia, Novo Mesto

Tel: +386 7 337 6650
parker.slovenia@parker.com

TH – Thailand, Bangkok

Tel: +662 717 8140

TR – Turkey, Istanbul

Tel: +90 216 4997081
parker.turkey@parker.com

TW – Taiwan, Taipei

Tel: +886 2 2298 8987

UA – Ukraine, Kiev

Tel: +380 44 494 2731
parker.ukraine@parker.com

UK – United Kingdom, Warwick

Tel: +44 (0)1926 317 878
parker.uk@parker.com

US – USA, Cleveland

Tel: +1 216 896 3000

VE – Venezuela, Caracas

Tel: +58 212 238 5422

ZA – South Africa, Kempton Park

Tel: +27 (0)11 961 0700
parker.southafrica@parker.com

